

EasyTouch
355
Operating Manual
Revision 1.11

Contents

Did I buy the right thermostat?	4
Installing the thermostat	4
Removing the old thermostat	4
Wiring the thermostat	5
Mounting the thermostat	6
Setup	7
Setting the available modes.....	7
Heat output setup.....	7
Connecting remotely.....	7
Operating the thermostat.....	8
Main screen.....	8
Away screen (Heat and cool set points).....	10
Weather Reporting	10
Schedule screen	11
Setting a change event.....	11
12- or 24-hour format.....	11
Setting the time	11
Enabling the schedule	11
Settings Screens	12
Back	12
Next, Last	12
System help.....	12
Day/Night mode.....	12
Schedule, Enabled, Disabled	12
WIFI Information.....	12
Bluetooth Reset	12
Brightness.....	12
Temperature reading adjustment.....	13
Temperature Gap.....	13
Measurement units.....	13
Touchscreen Calibrate	13
Restart.....	13
Reset All	13
Switches	13

Generator start	13
Furnace/Aqua.....	14
Gas Heat Override.....	15
Smart device application only features	15
Reset device	15
Calibrate Touchscreen	15
Check for updates	15
Notifications.....	16
Appendix A: Installation Troubleshooting	17
WIFI Troubleshooting.....	17
No WIFI Icon.....	17
Red WIFI Icon	17
Appendix B: Connecting remotely	18
First connection steps	18
Adding a control.....	18
Connecting to a new WIFI network	18
Updating the thermostat	18
Appendix C: 9430-334 wiring.....	19

Did I buy the right thermostat?

The EasyTouch 355 model thermostats were designed to directly replace Coleman™, Airxcel™ and RVP™ ZC thermostats. Original thermostats must have model numbers of 9330-333, 9330-334, 9330-335, 9330-336, or 9430-334 to be replaced by this thermostat. If your thermostat is not listed, please contact Micro-Air <https://www.micro-air.com/SupportRequest> to verify the thermostat you received is correct for your application.

Installing the thermostat

There are three steps to installing the thermostat. First remove your old thermostat. Next disconnect and reconnect the wiring. Finally install the mounting pins to the wall and mount your new thermostat. These steps are explained in detail in the following sections.

Removing the old thermostat

The original thermostat is held to the wall with a backing plate that extends about $\frac{1}{4}$ " (6.3mm) from the wall. The thermostat can be "popped off" the plate to access the mounting screws behind it. Remove the screws and unplug the two connections on the cable harness. Note, some thermostats are directly wired by the manufacturer. See the next section for further details before disconnecting the wires.

Wiring the thermostat

Original thermostats can have a plug-in connector or be direct wired to the RV manufacturer's wiring. Thermostats wired with a plug can simply unplug the original plug and plug in the EasyTouch thermostat. Wired thermostats require the optional connector which can be ordered with the thermostat or ordered separately.

To wire the connector models, match the original thermostat wiring colors to the connector colors. Please note that manufacture wiring from the wall may not match the colors until it joins with the wiring stub from the original thermostat. See Table 1 for details on the colors used with the thermostat and the function of the wires.

Note: See [Appendix C: 9430-334 wiring](#) for a different wiring table when replacing model number 9430-334.

Table 1

	Original thermostat wire color	Micro-Air harness color	Function	Factory harness color (Provided to write in your color)
2-pin connector	Purple	Purple	Signal 1	
	Black	Black	Signal 2	
9-pin connector	Green	Green	Heat 4	
	White	White	Heat 1	
	Blue	Blue	Ground in	
	Red/White stripe	Red/White stripe	+12 VDC out	
	Red	Red	+ 12 VDC in	
	Blue/White stripe	Blue/White stripe	Ground out	
	Orange	Orange	Heat 2	
	Yellow	Yellow	Heat 3	
	-----	Purple	None	Do not connect

Mounting the thermostat



Step 1: Locate the mounting buttons horizontally across the hole with the smaller diameter against the wall.



Step 2: Screw in one screw and level the buttons so the display will be straight when installed.

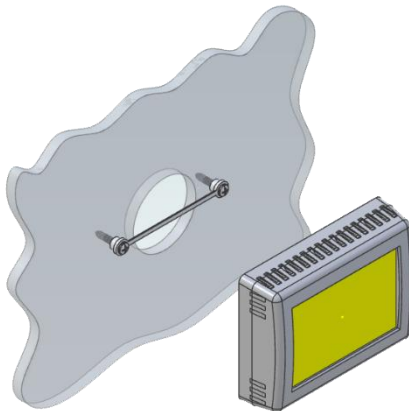

Step 3: Screw in second screw making sure the two buttons remain level.

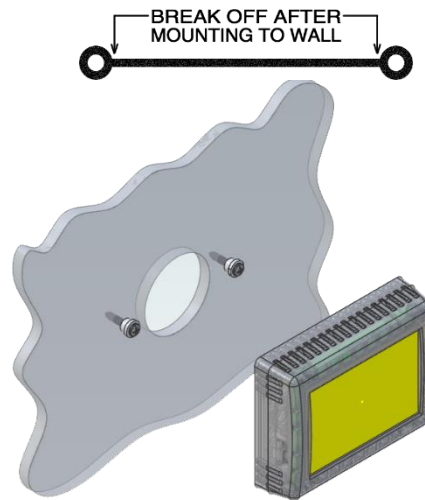



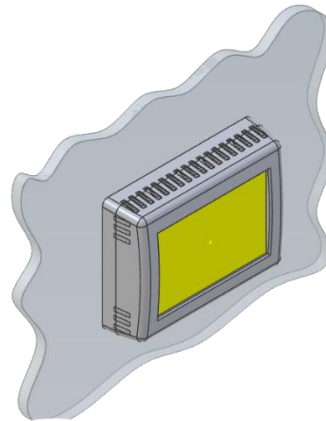

Step 4: Remove mounting tab before mounting on the wall.



Step 5: Aligning the buttons with the holes in the back of the display. Press the display against the wall and gently slide the display down to lock it in place.

Setup

Setting the available modes

It is necessary to set up the available modes prior to operating your thermostat. Press the settings button  on the main screen. Select the available modes  button on the settings screen. Select cooling,  Gas heat,  or electric heat  by pressing the icon. The red circle with a line through it will disappear indicating the mode is available. Available modes must match your original thermostat's available modes. Use the zone button to set them appropriately for each available zone.

Heat output setup

There is text in the available modes screen that reads "Normal" as shipped from Micro-Air. Pressing this text, changes the operating modes to different options to support specific thermostats.

Option 1 must be selected when replacing a thermostat with a model number of 9330-333. These models feature fan speed control of the roof fans in heating modes. Press the "Normal" text in the available modes screen to change the option to "Option 1" when replacing this thermostat. Please note these systems used different control boards for this feature.

Option 2 must be selected when replacing a thermostat with model number 9430-334. Press the "Normal" text in the available modes screen to change the text to "Option 2" when replacing this thermostat. See [Appendix C: 9430-334 wiring](#) for more information on these systems.

Connecting remotely

This thermostat may be operated remotely using either Bluetooth or WIFI. Apps may be loaded from the Google Play store or Apple App store. The first time the app is opened, it will ask to create an account. A WIFI connection on your smart device is necessary for this step. Create your account and follow the prompts to connect your thermostat.



EasyTouch icon

If a second user is going to use the thermostat remotely, they can use the same account and password as the first user. Each thermostat can only be assigned to a single account.

Operating the thermostat

Main screen

1. Inside temperature shows the ambient temperature of the room.
2. WIFI indicator shows the state of the WIFI connection. Green indicates WIFI is connected properly, Red indicates connection to router only, bars indicate signal strength, and no symbol indicates no connection.
3. Raise and lower the temperature set point using the red and blue arrows.
4. Use the power button to turn the system on or off. Button is red for off and green for on.
5. Pressing the mode icon changes from cooling or heating modes depending on what is available in your system. See Table 2 for a list of all possible modes.

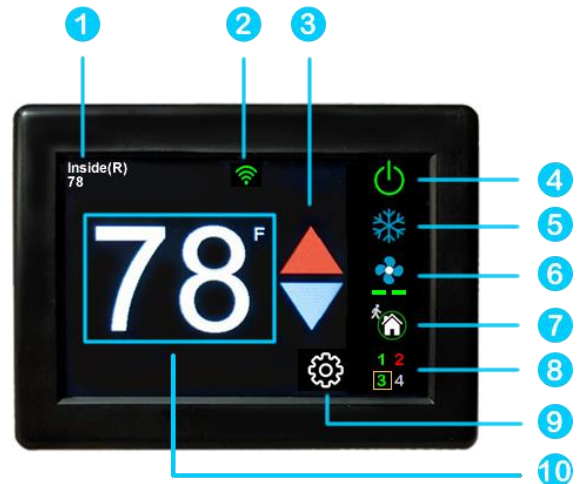















Table 2

	Fan only		Automatic
	Cool Only		
	Gas heating		Zone off
	Electric Heating		Zone on

6. Pressing the fan icon selects between manual (always on) fan speeds and automatic fan speeds. Automatic will turn the fan off after the heating or cooling cycle is completed. See Table 3 for available fan speeds.

Table 3

	Indication	Available in mode		Action
		Normal	Option 1	
	Manual fan low	Manual fan, Cooling	Manual fan, cooling, electric heat, gas heat	Fan runs continually on low
	Manual fan high	Manual fan, Cooling	Manual fan, cooling, gas heat, electric heat	Fan runs continually on high
	Auto fan	Cooling, Auto	Cooling, Auto	Fan cycles with compressor or electric element

	Auto fan low	N/A	Electric heat, gas heat	Fan turns on in low when heat is running
	Auto fan high	N/A	Electric heat, Gas heat	Fan turns on in high when heat is running
	Fan off	N/A	Gas heat	Fan does not turn on when gas heating is active

Note: Auto fan speed changes with temperature. More than 1 degree from set point will run the high fan. The fan will run the low fan speed within one degree of set point.

7. Home-away-schedule icon. Pressing this button selects between these modes. Home mode is the normal operating mode using a single set point for temperature control. Schedule mode allows changing set points throughout the day programmatically. Away mode allows setting a heating and a cooling set point and automatically changing from heating to cooling.
8. The zone selection button will show a zone in green when it is turned on. The zone number will show in gray if the zone is not available and in red if there is a fault with the zone. A frame will show around the zone number to indicate it is selected.
9. Pressing the gear will change the settings screen to allow additional setup functions.
10. Pressing the set point will change the system units from °F to °C and back. The set point is also used as an indicator of system operation. A red set point indicates a heating cycle is in process. A blue set point indicates a cooling cycle is in process. A white icon indicates no cycle is in process.

Away screen (Heat and cool set points)



Away operation allows setting upper and lower limits for temperature with a non-operating area or “dead band” in the middle. This can be useful when setting a higher daytime cooling temperature and lower nighttime heating temperature. It can also be used to control the temperature extremes when you are away from the RV. The mode selected must be an automatic mode to allow both heating and cooling operation.

1. Press the set points area to toggle between the selected values. A blue square will show around the value you are changing. The upper value changes the cooling set point, and the lower value changes the heating set point.

2. Use the up and down arrows to change the selected temperature value.

Weather Reporting

Weather data is returned from a weather service for your location when the thermostat is connected to the internet. Weather information is updated whenever you touch the thermostat or connect on Bluetooth or WIFI. The thermostat must have the green WIFI logo to receive weather data.

Location is set whenever you connect on Bluetooth only. Location can be checked by pressing the weather icon and viewing the location on the bottom of the screen. [Reconnect to the thermostat using your smart device and the EasyTouch RV to update to your current location.](#)

Schedule screen

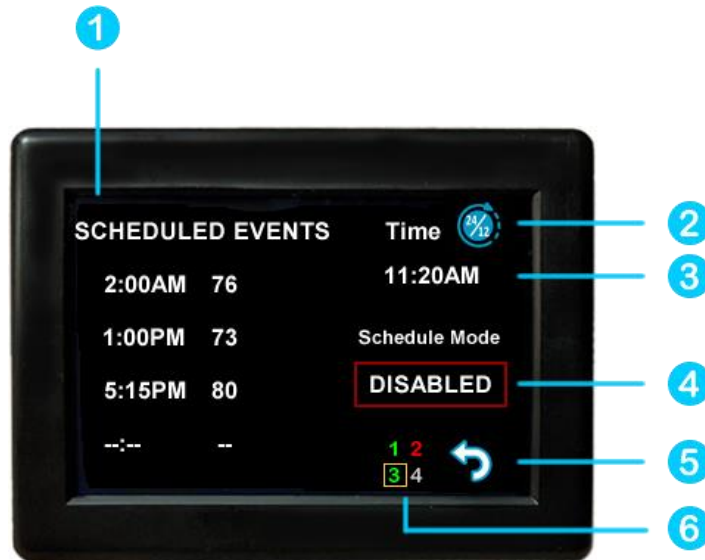

Set points may be changed on a time-based schedule. The mode used will be the heating or cooling mode set on the main screen.

Setting a change event

1. Events will show --:-- when the event is disabled. Press the hour's position to set the hours. A flashing bar will appear under the hours along with up and down adjustment selectors. Use the adjustment selectors to change the hours.

Press the minutes to move the flashing bar under the minutes and allow $\frac{1}{4}$ hour adjustments. Use the up and down adjustment selectors to make changes.

Press the temperature to change the desired temperature set point. This is the temperature the system will try to achieve after the time that was set.

12- or 24-hour format

2. Press the time in the upper right to change 12 and 24-hour time formats.

Setting the time

3. Time zone is set and saved whenever the thermostat connects using Bluetooth. Time is set on power up through the internet connection, or whenever a connection is made on either Bluetooth or WIFI.

Enabling the schedule

4. Press the enabled/disabled button to enable the schedule. The schedule will be active and make set point changes anytime the schedule is selected on the main screen. The Home/Schedule/Away button will only toggle between schedule and away when the schedule is enabled. The button will only select between home and away if the schedule is disabled. Away mode is not configurable on a schedule.

5. Press the round arrow to return to the regular settings screen.

Settings Screens



Press the settings gear on the main screen to show various settings options. Each icon has a description below it indicating the function of the icon. Some descriptions can change depending on the option selected. Please note that some options shown are specific to certain thermostats or selected options.

Back



Back returns you to the main screen.

Next, Last



Next and last allow navigating to various settings options.



System help



Displays a scannable QR code that provides information about thermostat operation and troubleshooting from the Micro-Air web site. Also provides thermostat serial number and the current firmware version of the thermostat.

Day/Night mode



Day mode (sun icon) will dim the display down to the screen saver set point after 30 seconds.



Night mode (moon icon) will turn off the back light after 30 seconds. The display will brighten again once the touch screen is pressed. See (8) to set brightness.

Schedule, Enabled, Disabled



Schedule icon will turn on and off the schedule operation. A second schedule icon will allow editing of the schedule settings. See the schedule section for more information.

WIFI Information



View your WIFI settings and MAC address as well as signal strength to the thermostat. Changes to the WIFI connection must be made using the smart device application.

Bluetooth Reset



Bluetooth is used to reset the Bluetooth password. This password is saved from your account password. Only one account at a time may access the thermostat. Reset the password whenever you change your account password.

Brightness



Set the main screen brightness and the screen saver brightness.

Temperature reading adjustment



Allows changing the internal thermostat sensor calibration. This function works only when “R” is not displayed after the inside temperature on the main screen. Sensors showing an “R” indicate the system is using remote sensors located in the air conditioner and they cannot be adjusted from the thermostat.

Temperature Gap



This sets the difference in temperature before an action will occur. For example, if the set point is 75° (24°C) and it goes up 1°, the system is in cooling and the gap is set for 1°, the thermostat will start a cooling cycle. Setting the gap larger will force the thermostat to see 2, 3, or 4 degrees before starting a cycle. This is helpful in preventing short cycling of the heating or cooling systems. *Note: Not available on all thermostat models*

Measurement units



Measurement units are labeled Celsius and Fahrenheit for simplicity. Set for Celsius to use metric units.

Touchscreen Calibrate



This forces a calibrate screen to appear to allow the user to set the touch points on the screen. Use a blunt pencil or similar implement to touch the four corner markers as they appear. Use the three diagonal markers to test the calibration. If the circles overlap even a little it is sufficient to give good touch results.

Restart



The restart icon allows restarting the thermostat as if you powered it off and on again. The Micro-Air logo will display followed by the main screen. This option can help recover from certain problems like a lost WIFI connection.

Reset All



This option resets certain settings in the thermostat. Some thermostats offer options to reset different parts of the memory to factory settings.

Switches



This option varies by thermostat. Some display the settings provided by the remote dip switches on the control board. Others allow setting some factory options like heating modes. Please see the [Thermostat Setup](#) section to determine actions needed to set up your thermostat.

Generator start



[Remote g](#)enerator start is an option found on some thermostats. Set the icon for the color version to turn on the generator when a cooling or heating cycle is needed. Set it for gray when it is not needed.



*Generator start option is not available for the 351, 352, 356, or 359 thermostats.

Furnace/Aqua



Users who have a water heated system instead of a furnace can change the furnace icon to an Aqua icon. This makes it easier to determine the mode for some users.



Gas Heat Override

This feature turns on the gas furnace from an electric heat mode when the set point is five or more degrees away from the ambient temperature and heating is required. It is only available on systems that have both gas and electric heating and is only active in electric heat or cool/electric heat modes.

If heating set point is 5 degrees or more above the inside temperature in an electric heating mode, the furnace will come on along with the electric heater. Both will remain on until the set point is reached. If this action is necessary more than twice in a row, gas heat will be used for the next two hours without electric heating. This is indicated by a red circle and line through the electric mode button.

When the furnace is actively overriding the electric heat, a furnace symbol will appear at the top of the thermostat screen.

Smart device application only features

Reset device

This Bluetooth only feature allows resetting the display just as if you removed and restored power.

Calibrate Touchscreen

It is normally not necessary to recalibrate the touchscreen. This selection prompts the user to press the four corners of the display then test the calibration using three diagonal marks. This feature is only available from Bluetooth.

Check for updates

Check to see if any updates are available for the thermostat. The smart device application must have internet and the thermostat must be connected to WIFI with a green WIFI symbol. Tap Check for Updates and follow the prompts.

Notifications

Notifications provide a way for the thermostat to communicate back to a smart device like a tablet or phone. These notifications are indications of the temperature exceeding a set limit. Limits are set by connecting to the thermostat in the app, selecting the settings gear, and then selecting notifications. A minimum and maximum allowed temperature can be set. Table 4 shows an example of operation with an 80°F maximum temperature set. Notification will be sent for each degree it rises above the maximum temperature. If temperature drops, no notification will be sent unless the temperature exceeds the last maximum temperature again (82 in the example). If the temperature drops two degrees below the set maximum, (78 in the example) it will again alert for each degree above the set maximum. This behavior helps avoid nuisance notifications to your smart device.

Table 4

Temperature °F	Action
80	Send first notification
81	Send another notification
82	Send another notification
81...79	Temperature drops, no notification
78	Max temp resets

Appendix A: Installation Troubleshooting

The most common problem is not knowing the thermostat operation. If the system is running a heating or cooling cycle, the set point will turn red for heating and blue for cooling. When the thermostat turns white, the heat pump, heat strip and furnace should all be off. The fan may continue to run for a while after the cycle completes. If a fan is left in a manual mode, it will not shut off.

WIFI Troubleshooting

No WIFI Icon

- SSID (Network name) and password are both case sensitive.
- Be sure you are connecting to a 2.4 GHz network and not a 5GHz or 6GHz network.
- Set the security to WPA2 and TKIP+AES if you are having trouble.
- The thermostat has a limit of 31 characters for the SSID and 50 for the password.
- The number of devices limit for the network is not full.
- The WIFI source is not out of range or metal partitions blocking the signal
- Reset the router to renew the DHCP lease.
- If you are in a metal enclosure, try moving the router or thermostat a few inches (even if temporary) and trying again.
- If using MAC filtering, add the thermostat to the allowed devices list.

Red WIFI Icon

- The router must have an internet connection
- Server may be down, check back at a later time
- Be sure there is no firewall in the router blocking the incoming messages (port 443, HTTPS).

Appendix B: Connecting remotely

First connection steps

1. This thermostat uses BLE which is a special implementation of Bluetooth. It is not necessary to “Pair” the thermostat with the phone but an account must be created for operation.
2. Start the app on your smart device. The app will open and if you have not entered your account information, it will ask you to create an account. Enter your name, email and a password at the prompts. The system will send a confirmation email to your inbox. Enter the number in the confirmation email when asked.
3. Once the account is created, the application may ask to add a device. If your device is powered it will show in the list to be added to your account. Select the control and enter a name or location for the control.
4. If you added a control, the app will ask if you want to connect to WIFI now. Enter your SSID (network name) and password in the boxes.

Adding a control

Follow the next steps if the account process does not add a control or a second thermostat is to be added.

1. Press “Add” on the top of the selection screen (Apple) or press the settings gear and “Add Device” (Android).
2. The second thermostat should be listed in the new selection window. Select the device and enter a name for the device.
3. Press OK and the screen will return to the settings menu (Android) or the selection screen (Apple). Android users should press the back button to get to the selection screen.
4. Select the device name to open the thermostat screen.

Connecting to a new WIFI network

1. Connect to the thermostat in Bluetooth (Apple) and press the settings gear.
2. Select WIFI Setup from the settings window.
3. Enter the SSID (network name) and password (Both case sensitive).
4. Press OK and the screen will return to the selection screen. The thermostat will reset and a green WIFI symbol will appear on the thermostat screen if the connection was successful.

Updating the thermostat

Ensuring you have the latest thermostat software is key to having all the latest features.

1. Ensure the thermostat is connected to WIFI with a green WIFI symbol.
2. Connect to the thermostat and press the settings gear, then tap Check for Updates.
3. Follow the prompts to update the thermostat or ensure that you already have the latest software.

Appendix C: 9430-334 wiring

Table 5

	Original thermostat wire color	Micro-Air harness color	Function	Factory harness color (Provided to write in your color)
Two Pin Connector	Purple	Purple	Signal 1	
	Black	Black	Signal 2	
Nine Pin Connector	Green	Green	Zone 2 On	
	White	White	Zone 1 High	
	Blue	Blue	Ground in	
	Red/White stripe	Red/White stripe	+12 VDC out	
	Red	Red	+ 12 VDC in	
	Blue/White stripe	Blue/White stripe	Ground out	
	Orange	Orange	Zone 2 High	
	Yellow	Yellow	Zone 1 On	
	-----	Purple	None	Do Not Connect

Table 5 shows the wiring functions used for this model thermostat. Option B must be selected in the settings' switches menu. Only two heating zones are possible in this configuration. Yellow and green are used to turn on single stage furnaces for zones 1 and two respectively. This can be used in Aqua hot systems as well to turn on each of the two zones for heating.

Two stage furnaces like certain suburban models use the orange and white wires to turn on the high furnace fan and high gas valve. This feature activates high furnace if the ambient temperature is more than four degrees below the set point.